

Hall IC Series

Bipolar Latch Hall IC

BU52040HFV

No.10045EBT05

●Description

BU52040 Hall Effect IC for wheel keys / trackballs is designed to detect a switch in magnetic field from N to S (or vice versa) and maintain its detection result on the output until the next switch. Output is pulled low for S-pole fields and high for N-pole fields. This IC is ideal for detecting the number of shaft rotations inside of a wheel key, trackball, or other similar applications. Using two ICs can also enable detection of rotation direction.

●Features

- 1) Ideally suited for wheel keys or trackballs
- 2) Micropower operation (small current consumption via intermittent operation method)
- 3) Ultra-small outline package
- 4) Supports 1.8 V supply voltage
- 5) High ESD resistance: 8kV (HBM)

●Applications

Wheel keys (zero-contact selection dials), trackballs, and other interface applications.

●Product Lineup

Product name	Supply voltage (V)	Operation point (mT)	Hysteresis (mT)	Period (μ s)	Supply current (AVG) (μ A)	Output type	Package
BU52040HFV	1.65~3.30	+/-3.0 [※]	6.0	500	200	CMOS	HVSO5

※Plus is expressed on the S-pole; minus on the N-pole

●Absolute Maximum Ratings

BU52040HFV (Ta = 25°C)

Parameters	Symbol	Limit	Unit
Power Supply Voltage	V _{DD}	-0.1~4.5 ^{※1}	V
Output Current	I _{OUT}	± 0.5	mA
Power dissipation	P _d	536 ^{※2}	mW
Operating Temperature Range	T _{opr}	-40~+85	°C
Storage Temperature Range	T _{stg}	-40~+125	°C

※1. Not to exceed P_d

※2. Reduced by 5.36mW for each increase in Ta of 1°C over 25°C(mounted on 70mm×70 mm×1.6mm Glass-epoxy PCB)

●Magnetic, Electrical Characteristics

BU52040HFV (Unless otherwise specified, $V_{DD}=1.80V$, $T_a=25^{\circ}C$)

Parameters	Symbol	Limit			Unit	Conditions
		Min	Typ	Max		
Power Supply Voltage	V_{DD}	1.65	1.80	3.30	V	
Operation point	B_{op}	1.0	3.0	5.0	mT	
Release Point	B_{rp}	-5.0	-3.0	-1.0	mT	
Hysteresis	B_{hys}	-	6.0	-	mT	
Period	T_p	-	500	1200	μs	
Output High Voltage	V_{OH}	$V_{DD} - 0.2$	-	-	V	$B < B_{rp}^{*3}$ $I_{OUT} = -0.5mA$
Output Low Voltage	V_{OL}	-	-	0.2	V	$B_{op} < B^{*3}$ $I_{OUT} = +0.5mA$
Supply Current 1	$I_{DD1(AVG)}$	-	200	300	μA	$V_{DD} = 1.8V$, Average
Supply Current During Startup Time 1	$I_{DD1(EN)}$	-	3.0	-	mA	$V_{DD} = 1.8V$, During Startup Time Value
Supply Current During Standby Time 1	$I_{DD1(DIS)}$	-	2.0	-	μA	$V_{DD} = 1.8V$, During Standby Time Value
Supply Current 2	$I_{DD2(AVG)}$	-	300	450	μA	$V_{DD} = 2.7V$, Average
Supply Current During Startup Time 2	$I_{DD2(EN)}$	-	4.5	-	mA	$V_{DD} = 2.7V$, During Startup Time Value
Supply Current During Standby Time 2	$I_{DD2(DIS)}$	-	3.5	-	μA	$V_{DD} = 2.7V$, During Standby Time Value

※3. B = Magnetic flux density
1mT=10Gauss

Positive (“+”) polarity flux is defined as the magnetic flux from south pole which is direct toward to the branded face of the sensor.
After applying power supply, it takes one cycle of period (TP) to become definite output.
Radiation hardness is not designed.

●Figure of measurement circuit

B_{op}/B_{rp}

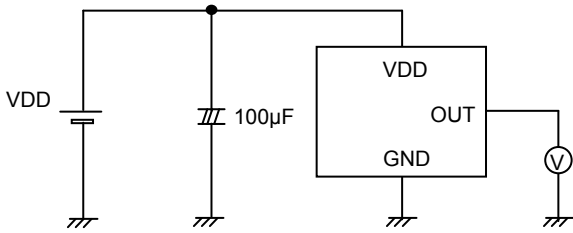

Bop and Brp are measured with applying the magnetic field from the outside.

Fig.1 B_{op},B_{rp} measurement circuit

T_p

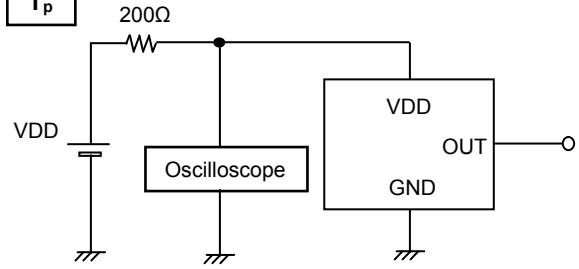

The period is monitored by Oscilloscope.

Fig.2 T_p measurement circuit

V_{OH}

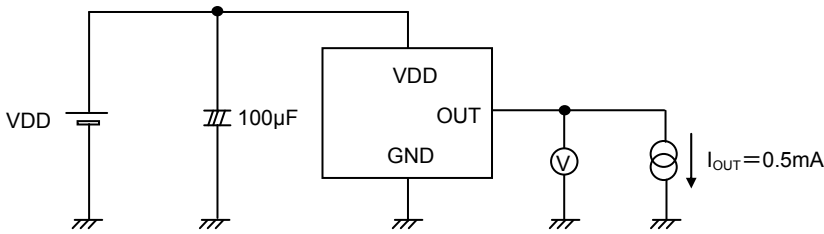

Fig.3 V_{OH} measurement circuit

V_{OL}

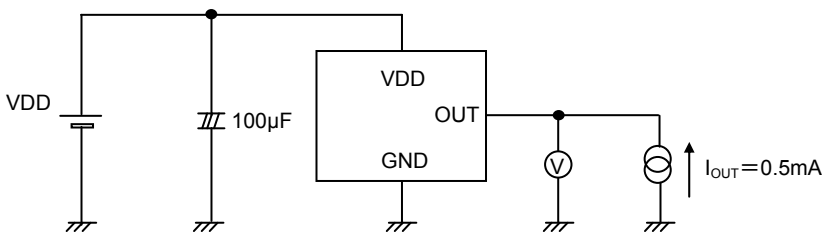

Fig.4 V_{OL} measurement circuit

I_{DD}

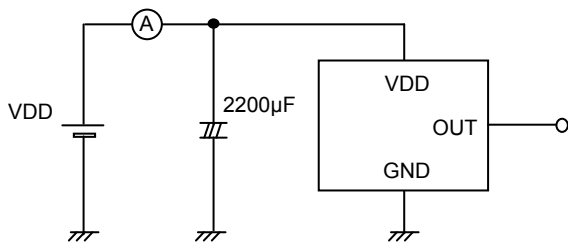

Fig.5 I_{DD} measurement circuit

●Reference Data

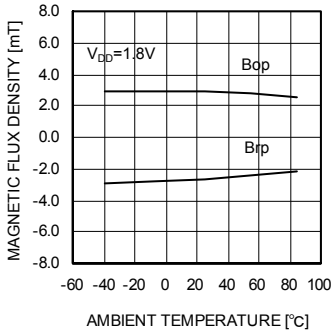

Fig.6 Bop,Brp– Ambient temperature

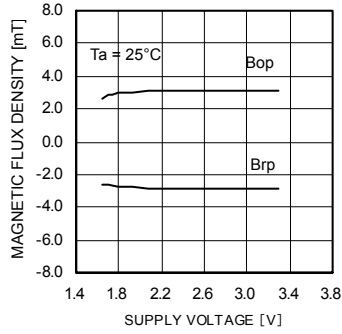

Fig.7 Bop,Brp– Supply voltage

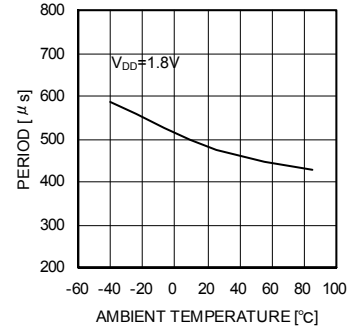

Fig.8 T_P – Ambient temperature

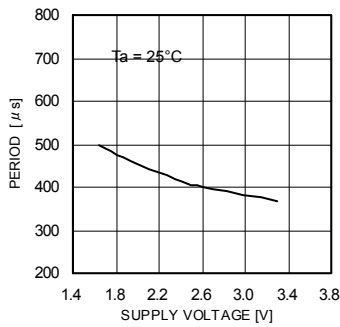

Fig.9 T_P – Supply voltage

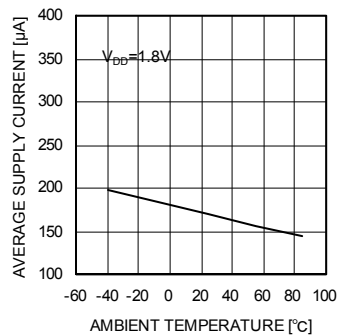

Fig.10 I_{DD} – Ambient temperature

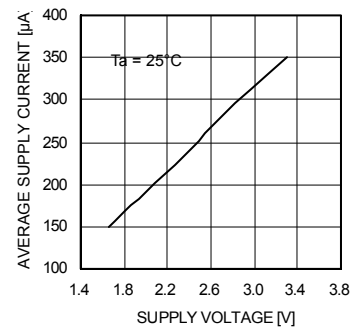

Fig.11 I_{DD} – Supply voltage

●Block Diagram

BU52040HFV

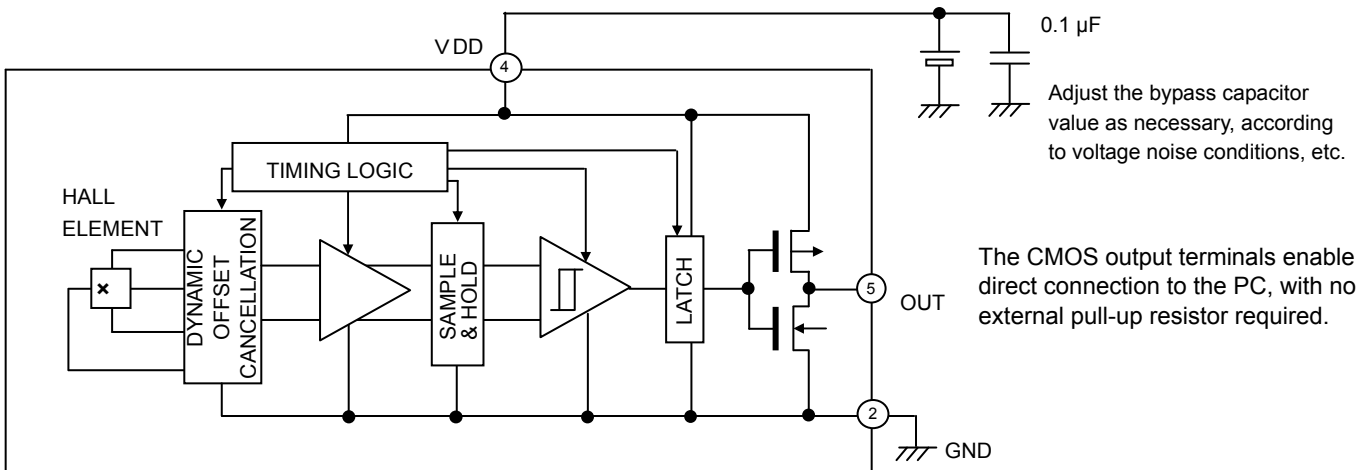
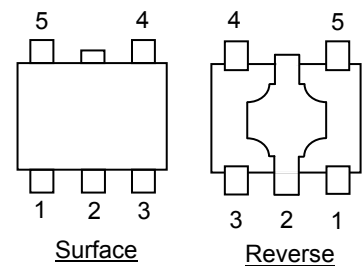

Fig.12

PIN No.	PIN NAME	FUNCTION	COMMENT
1	N.C.		OPEN or Short to GND.
2	GND	GROUND	
3	N.C.		OPEN or Short to GND.
4	VDD	POWER SUPPLY	
5	OUT	OUTPUT	



●Description of Operations

(Micro-power Operation)

The Hall Effect IC for wheel keys / trackballs adopts an intermittent operation method to save energy. At startup, the Hall elements, amp, comparator and other detection circuits power ON and magnetic detection begins. During standby, the detection circuits power OFF, thereby reducing current consumption. The detection results are held while standby is active, and then output.

Reference period: 500 μ s (MAX. 1200 μ s)

Reference startup time: 24 μ s

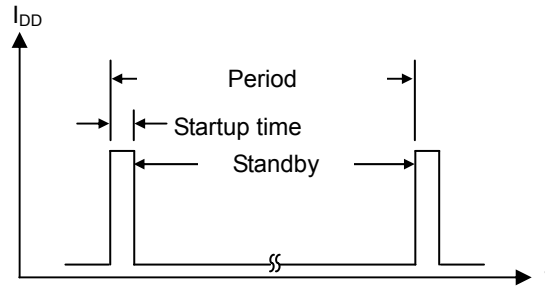

Fig.13

(Offset Cancellation)

The Hall elements form an equivalent Wheatstone (resistor) bridge circuit. Offset voltage may be generated by a differential in this bridge resistance, or can arise from changes in resistance due to package or bonding stress.

A dynamic offset cancellation circuit is employed to cancel this offset voltage.

When Hall elements are connected as shown in Fig. 14 and a magnetic field is applied perpendicularly to the Hall elements, voltage is generated at the mid-point terminal of the bridge. This is known as the Hall voltage.

Dynamic cancellation switches the wiring (shown in the figure) to redirect the current flow to a 90° angle from its original path, and thereby cancels the Hall voltage.

The magnetic signal (only) is maintained in the sample/hold circuit during the offset cancellation process and then released.

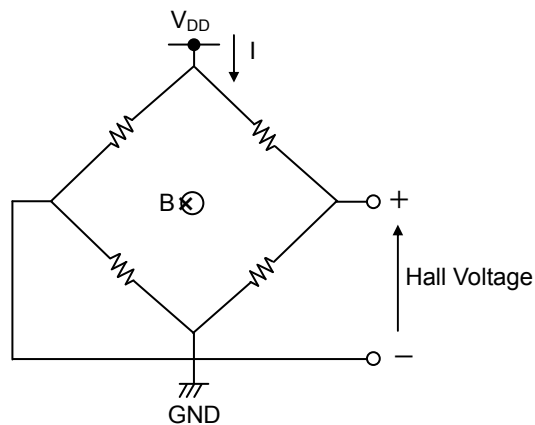

Fig.14

(Magnetic Field Detection Mechanism)

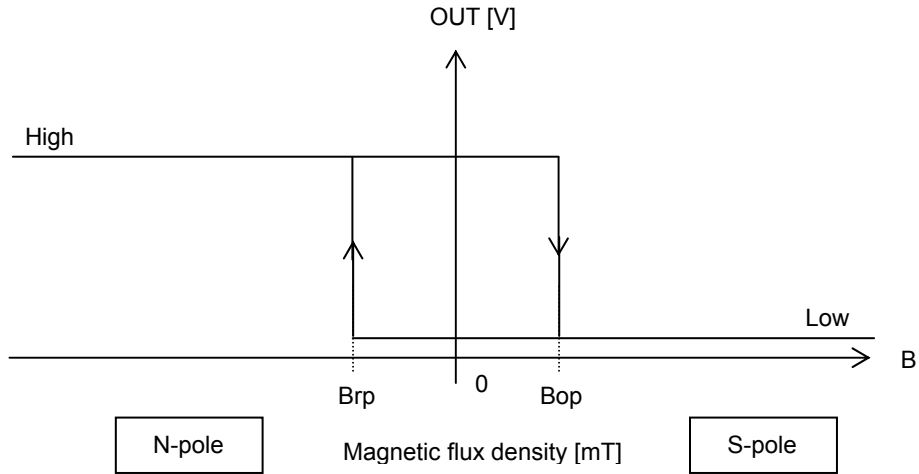

Fig.15

The IC detects magnetic fields that running horizontal to the top layer of the package. When the magnetic pole switches from N to S, the output changes from high to low; likewise, when the magnetic pole switches from S to N, the output changes from low to high. The output condition is held unit the next switch in magnetic polarity is detected.

[Operation in Continuously Changing Magnetic Fields]

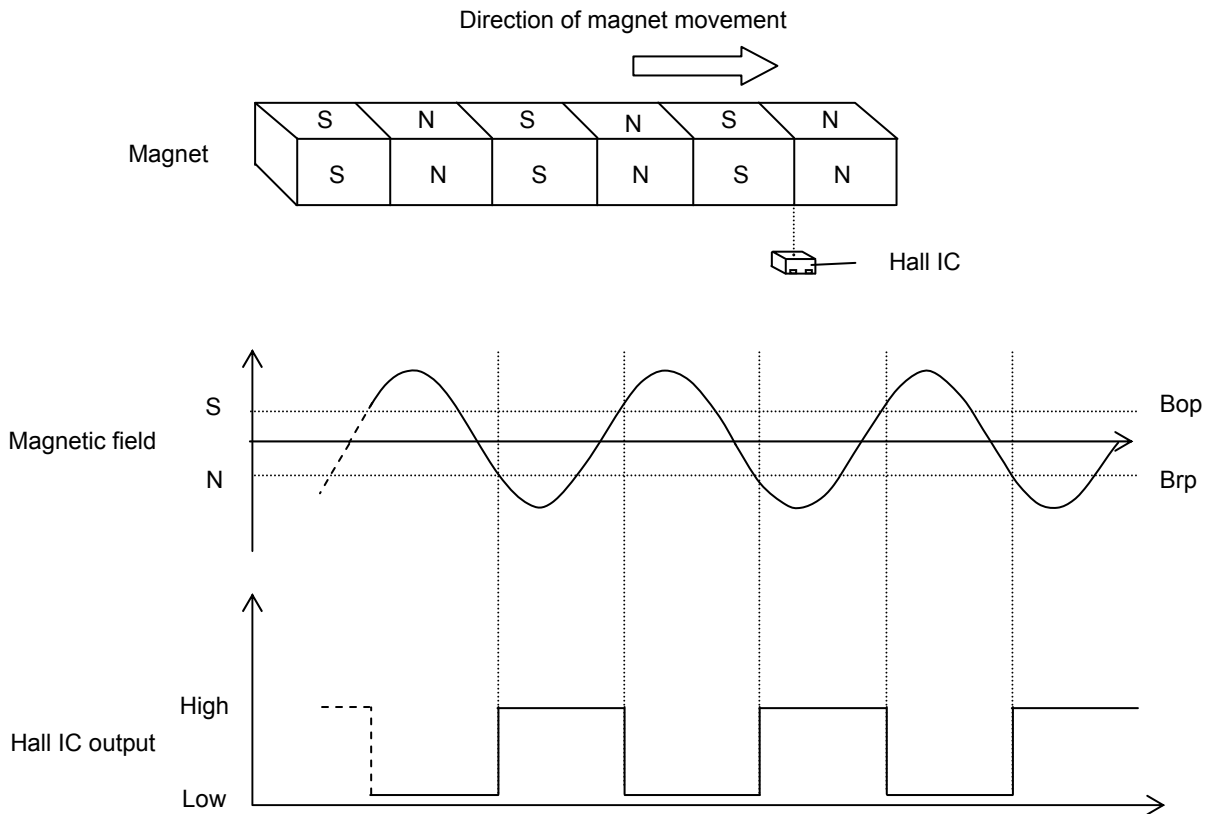

Fig.16

The IC can detect a continuous switch in magnetic field (from N to S and S to N) as depicted above.

● Intermittent Operation at Power ON

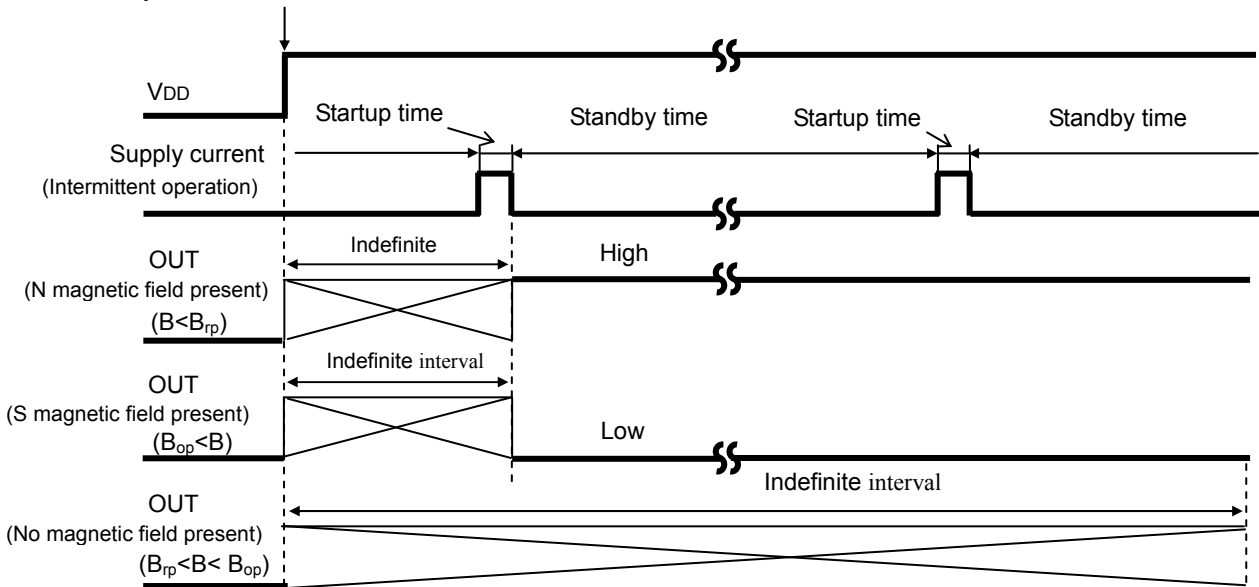

Fig.17

The Hall Effect IC for wheel keys / trackballs adopts an intermittent operation method in detecting the magnetic field during startup, as shown in Fig. 17. It outputs to the appropriate terminal based on the detection result and maintains the output condition during the standby period. The time from power ON until the end of the initial startup period is an indefinite interval, but it cannot exceed the maximum period, 1200 μ s. To accommodate the system design, the Hall IC output read should be programmed within 1200 μ s of power ON, but after the time allowed for the period ambient temperature and supply voltage.

Additionally, if a magnetic flux density (B) of magnitude greater than B_{rp} but less than B_{op} is applied at power ON, the output from the IC remains undefined and will be either high or low until a flux density exceeding the B_{op} or B_{rp} threshold is applied.

● Application Example

Wheel Key

Two Hall ICs can enable detection of rotation direction of a magnetic zero-contact wheel key.

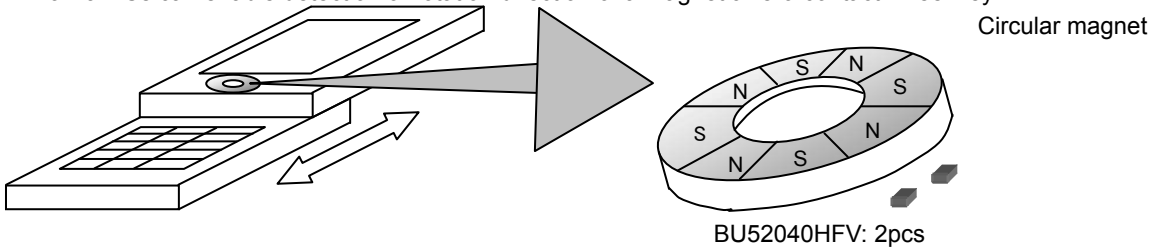

Mounting Position of Hall IC Inside Wheel Key

The angular separation of the two Hall ICs within the footprint of the wheel key depends on N/S division angle of the internal magnet (Φ), and can be set to either $\Phi/4$ or $3/4\Phi$. Mounting the two ICs in this position causes the magnetic phase difference between the ICs to equal $\pm 1/4$, and the direction of rotation can be detected by measuring the change in this difference. An example of the magnetic field characteristics for this application is shown in the figure below.

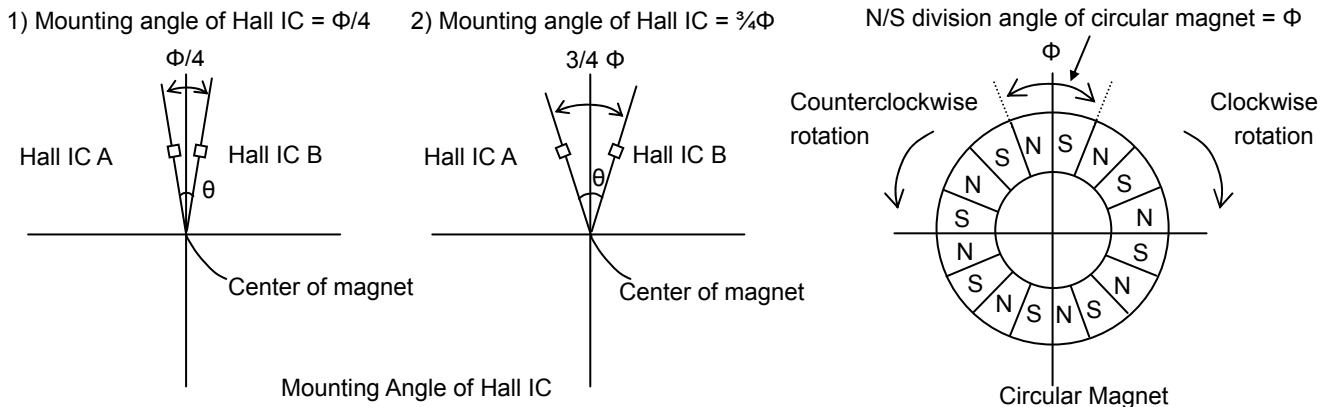

Detection of Rotation Direction

1) Mounting angle = $\Phi/4$

Clockwise Rotation

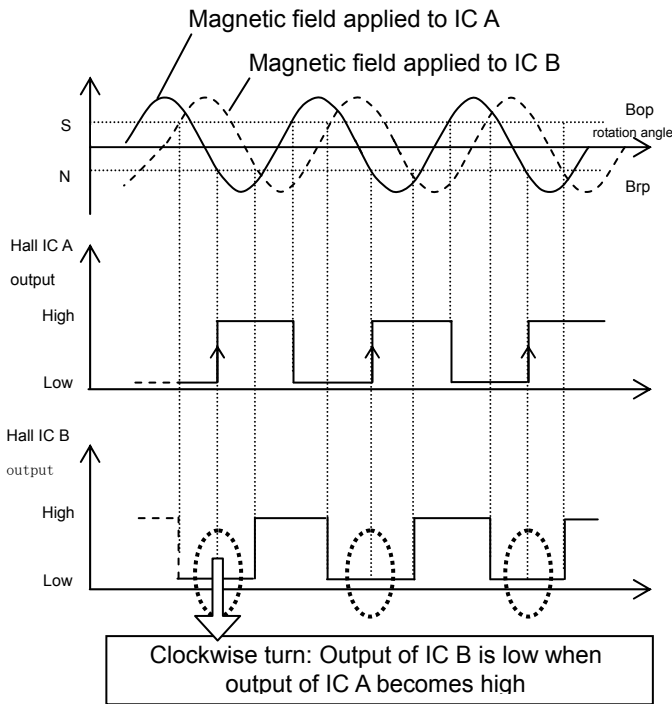

Counterclockwise Rotation

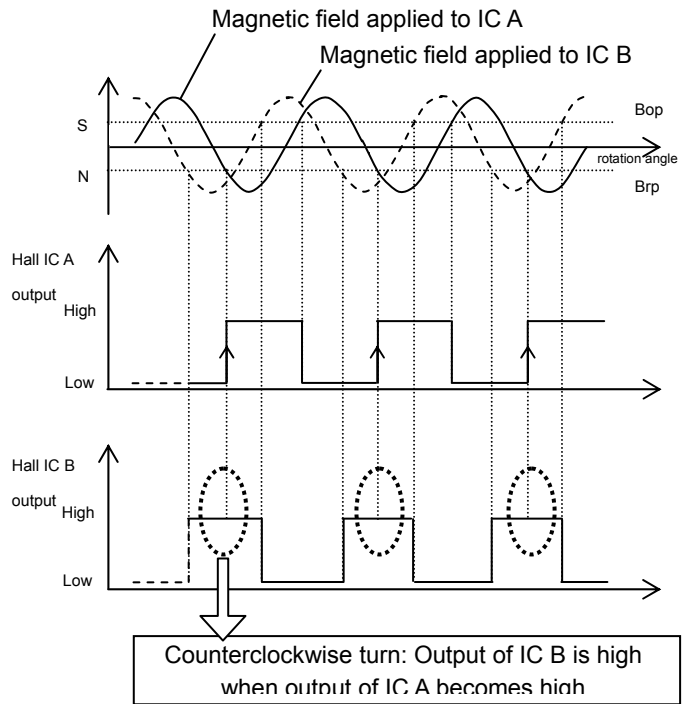

2) Mounting angle = $\frac{3}{4}\Phi$

Clockwise Rotation

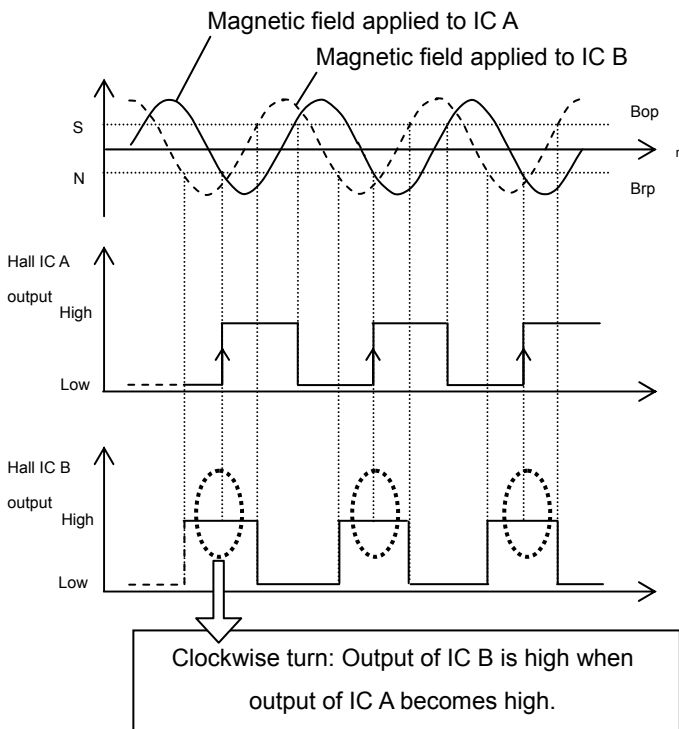

Counterclockwise Rotation

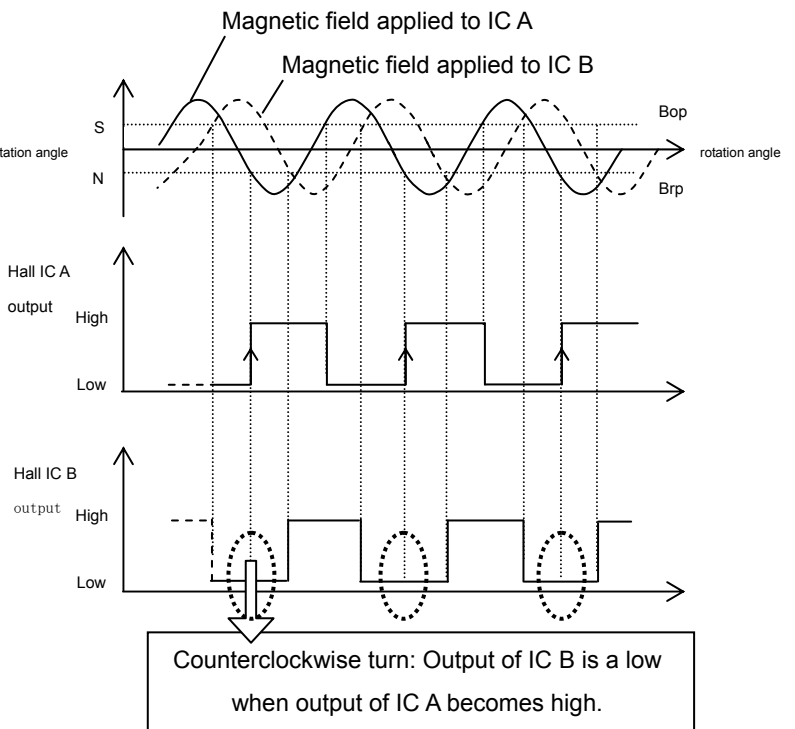

Because the IC measures changes in magnetic field every 1200 μ S, the IC cannot detect changes in rotation at speeds exceeding this period.

●Magnet Selection

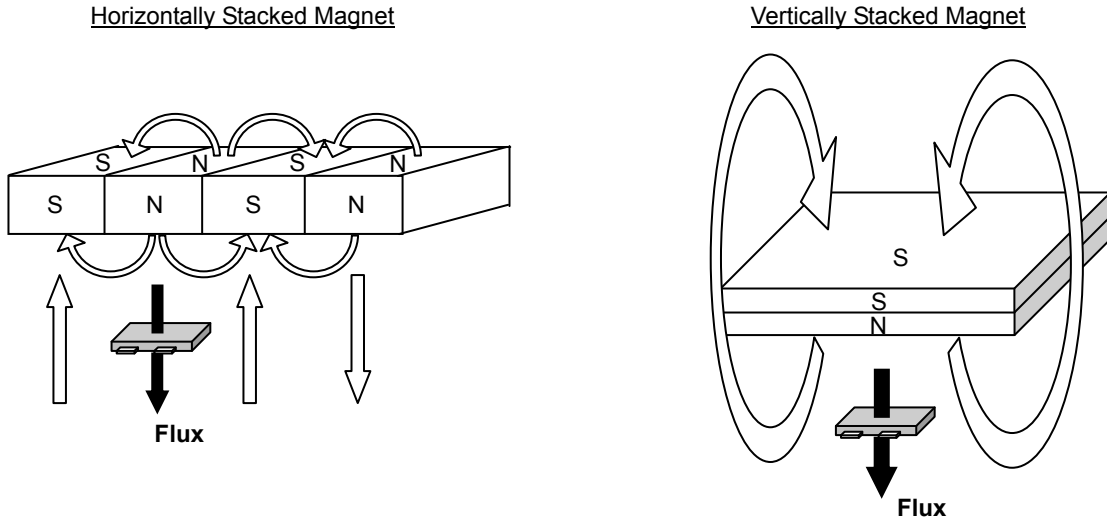

Because the field loop in horizontally stacked magnets extends for a shorter distance than that of vertically stacked magnets, the gap between the magnet and the hall IC must be decreased. Therefore, if horizontally-stacked magnets are used in the application, the thickness of the magnet or the area of each section should be increased to allow for a larger gap between the magnet and IC.

Because the IC is unable to detect rotation direction if using magnets that are smaller than the IC's package size, ensure that the physical size of each N/S division is larger than the IC's package, and that the ICs are properly mounted with an angular distance of either $\Phi/4$ or $3/4\Phi$ from one another (where Φ = N/S division angle of circular magnet).

●IC Reference Position

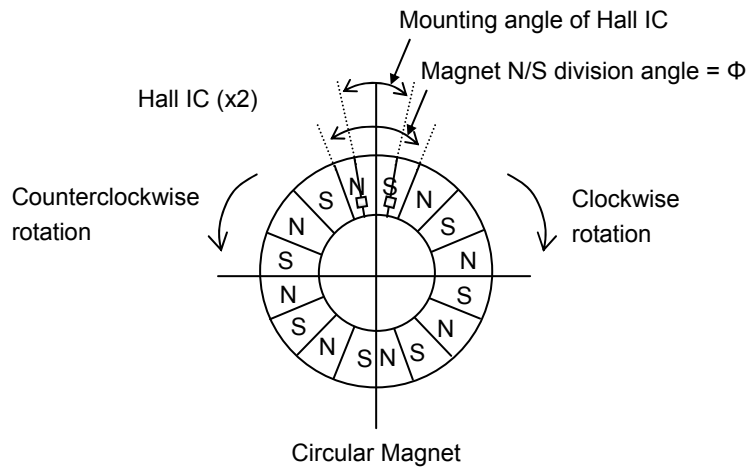

●Position of the Hall Effect IC(Reference)

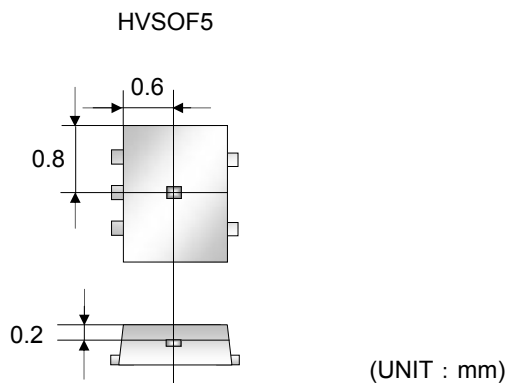

●Footprint dimensions (Optimize footprint dimensions to the board design and soldering condition)

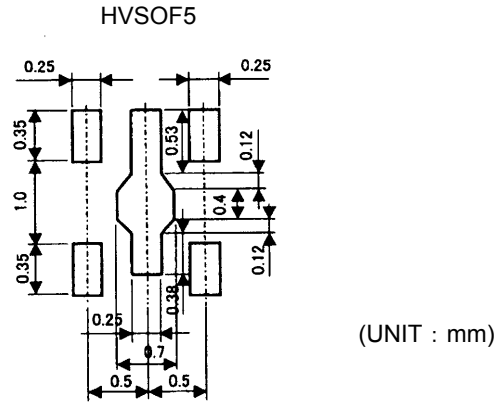

●Terminal Equivalent Circuit Diagram

Because they are configured for CMOS (inverter) output, the output pins require no external resistance and allow direct connection to the PC. This, in turn, enables reduction of the current that would otherwise flow to the external resistor during magnetic field detection, and supports overall low current (micropower) operation.

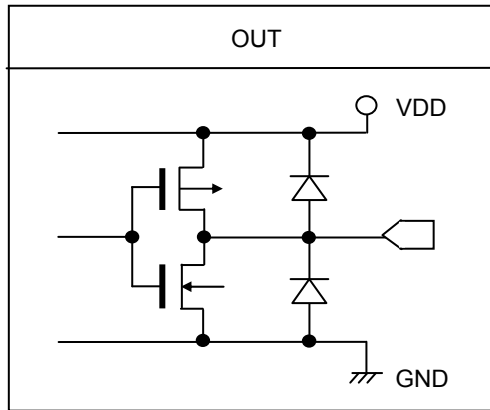

Fig.18

●Notes for use

- 1) Absolute maximum ratings
Exceeding the absolute maximum ratings for supply voltage, operating conditions, etc. may result in damage to or destruction of the IC. Because the source (short mode or open mode) cannot be identified if the device is damaged in this way, it is important to take physical safety measures such as fusing when implementing any special mode that operates in excess of absolute rating limits.
- 2) GND voltage
Make sure that the GND terminal potential is maintained at the minimum in any operating state, and is always kept lower than the potential of all other pins.
- 3) Thermal design
Use a thermal design that allows for sufficient margin in light of the power dissipation (Pd) in actual operating conditions.
- 4) Pin shorts and mounting errors
Use caution when positioning the IC for mounting on printed circuit boards. Mounting errors, such as improper positioning or orientation, may damage or destroy the device. The IC may also be damaged or destroyed if output pins are shorted together, or if shorts occur between the output pin and supply pin or GND.
- 5) Positioning components in proximity to the Hall IC and magnet
Positioning magnetic components in close proximity to the Hall IC or magnet may alter the magnetic field, and therefore the magnetic detection operation. Thus, placing magnetic components near the Hall IC and magnet should be avoided in the design if possible. However, where there is no alternative to employing such a design, be sure to thoroughly test and evaluate performance with the magnetic component(s) in place to verify normal operation before implementing the design.
- 6) Operation in strong electromagnetic fields
Exercise extreme caution about using the device in the presence of a strong electromagnetic field, as such use may cause the IC to malfunction.
- 7) Common impedance
Make sure that the power supply and GND wiring limits common impedance to the extent possible by, for example, employing short, thick supply and ground lines. Also, take measures to minimize ripple such as using an inductor or capacitor.
- 8) GND wiring pattern
When both a small-signal GND and high-current GND are provided, single-point grounding at the reference point of the set PCB is recommended, in order to separate the small-signal and high-current patterns, and to ensure that voltage changes due to the wiring resistance and high current do not cause any voltage fluctuation in the small-signal GND. In the same way, care must also be taken to avoid wiring pattern fluctuations in the GND wiring pattern of external components.
- 9) Power source design
Since the IC performs intermittent operation, it has peak current when it's ON. Please taking that into account and under examine adequate evaluations when designing the power source.

●Ordering part number

B	U	5	2	0	4	0	H	F	V	-	T	R
Part No		Part No 52040					Package HFV : HVSO5F5			Packaging and forming specification TR: Embossed tape and reel (HVSO5F5)		

HVSO5F5

(Unit : mm)

<Tape and Reel information>

Tape	Embossed carrier tape
Quantity	3000pcs
Direction of feed	TR (The direction is the 1pin of product is at the upper right when you hold reel on the left hand and you pull out the tape on the right hand)

*Order quantity needs to be multiple of the minimum quantity.

Notes

No copying or reproduction of this document, in part or in whole, is permitted without the consent of ROHM Co.,Ltd.

The content specified herein is subject to change for improvement without notice.

The content specified herein is for the purpose of introducing ROHM's products (hereinafter "Products"). If you wish to use any such Product, please be sure to refer to the specifications, which can be obtained from ROHM upon request.

Examples of application circuits, circuit constants and any other information contained herein illustrate the standard usage and operations of the Products. The peripheral conditions must be taken into account when designing circuits for mass production.

Great care was taken in ensuring the accuracy of the information specified in this document. However, should you incur any damage arising from any inaccuracy or misprint of such information, ROHM shall bear no responsibility for such damage.

The technical information specified herein is intended only to show the typical functions of and examples of application circuits for the Products. ROHM does not grant you, explicitly or implicitly, any license to use or exercise intellectual property or other rights held by ROHM and other parties. ROHM shall bear no responsibility whatsoever for any dispute arising from the use of such technical information.

The Products specified in this document are intended to be used with general-use electronic equipment or devices (such as audio visual equipment, office-automation equipment, communication devices, electronic appliances and amusement devices).

The Products specified in this document are not designed to be radiation tolerant.

While ROHM always makes efforts to enhance the quality and reliability of its Products, a Product may fail or malfunction for a variety of reasons.

Please be sure to implement in your equipment using the Products safety measures to guard against the possibility of physical injury, fire or any other damage caused in the event of the failure of any Product, such as derating, redundancy, fire control and fail-safe designs. ROHM shall bear no responsibility whatsoever for your use of any Product outside of the prescribed scope or not in accordance with the instruction manual.

The Products are not designed or manufactured to be used with any equipment, device or system which requires an extremely high level of reliability the failure or malfunction of which may result in a direct threat to human life or create a risk of human injury (such as a medical instrument, transportation equipment, aerospace machinery, nuclear-reactor controller, fuel-controller or other safety device). ROHM shall bear no responsibility in any way for use of any of the Products for the above special purposes. If a Product is intended to be used for any such special purpose, please contact a ROHM sales representative before purchasing.

If you intend to export or ship overseas any Product or technology specified herein that may be controlled under the Foreign Exchange and the Foreign Trade Law, you will be required to obtain a license or permit under the Law.



Thank you for your accessing to ROHM product informations.
More detail product informations and catalogs are available, please contact us.

ROHM Customer Support System

<http://www.rohm.com/contact/>